



SPARTAN

Hollow Metal Doors & Frames

Manufactured in Houston, Texas



Established in 1986 and headquartered in Lititz, Pennsylvania, Tell Manufacturing has worked to develop and maintain great relationships. It is because of our dedication in providing you with the best service that we can, that we continue to build long term loyal customers.

We have 6 different distribution centers to service your needs wherever you are. We also have keying service capabilities in each location to provide customizations, as necessary.

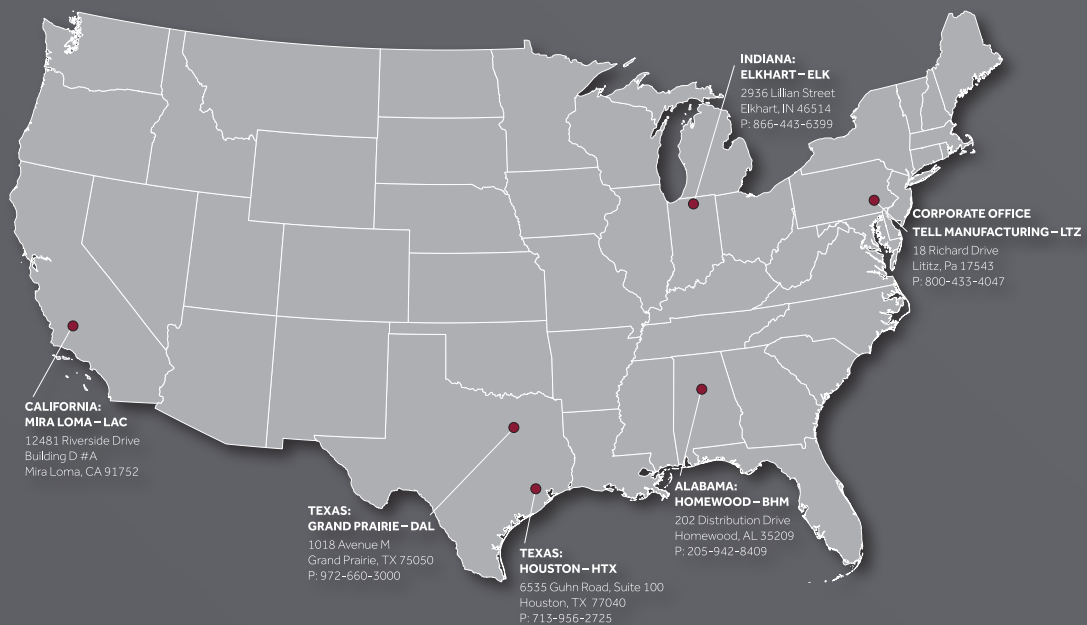

THERE'S MORE TO TELL ...

GALVANNEALED STEEL

Our metal doors and frames are made from galvanized steel.

What's galvanized steel and why?

We've all heard of galvanized steel. It's a process to create a corrosion resistant layer of protective zinc on steel. It's extremely common, durable, and reliable. Galvanized steel is different in that it is processed at a much higher temperature than galvanized steel. At the higher temperature, the iron in the steel combines with the protective zinc layer to create a zinc-iron alloy coating. As a result, galvanized steel is harder and stronger than galvanized steel, easier to weld and the surface is a matte finish that's more consistent and easier to paint on.



LITE KIT

We have an assortment of lite kits to choose from.

Let us know how you like the door.

Our lite kit frames are powder coated for improved corrosion resistance compared to conventional paint finishes. Powder coating is a process where charged powder is sprayed onto the grounded frames, binding evenly to the applied surface. It's then cured to create a robust surface finish that's durable and longer-lasting than conventional paint finishes.

TELL HARDWARE

Our selection of hardware gives you the security options you need.

Rest at ease knowing the door is secure.

Tell products are a smart way to minimize the risks of property damage and theft and help ensure safety in your modular buildings. For high-traffic, high-use applications, Tell locksets, door closers, exit devices and hardware are the right commercial solutions. Our products are proven performers, offering the ideal combination of quality, durability and security.

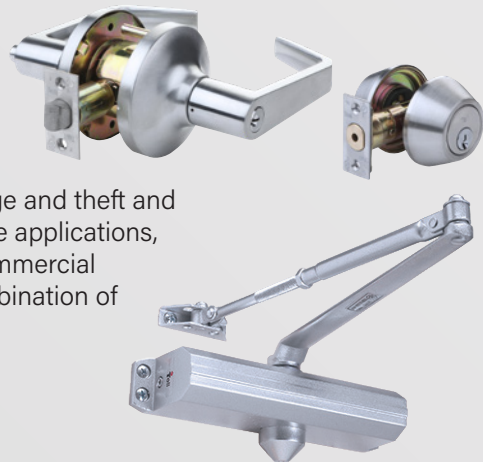

SPARTAN DOORS

ABOUT THE PRODUCT

The **Spartan Series Doors** are designed to meet the architectural requirements for hollow metal doors. This premium door construction combines the strength and dimensional stability of steel with the structural integrity of the polystyrene core. The continuous bonding of core to metal provides an attractive flat door, free of face welding marks. Windstorm Tests have proven that the Spartan door has integral high resistance to impact damage, low thermal conductivity, and high STC ratings. To meet application, specification and performance requirements, the Spartan offers a wide range of specifiable options including sizes, glass lite designs, hardware (mechanical, pneumatic, electrical) preparations and edge constructions.

Polystyrene core system enhances the structural integrity of the door, while significantly reducing the weight.

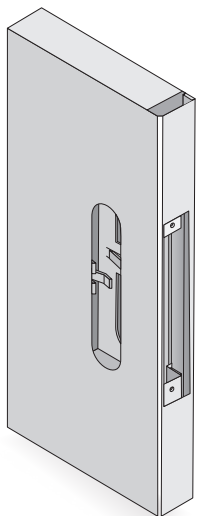
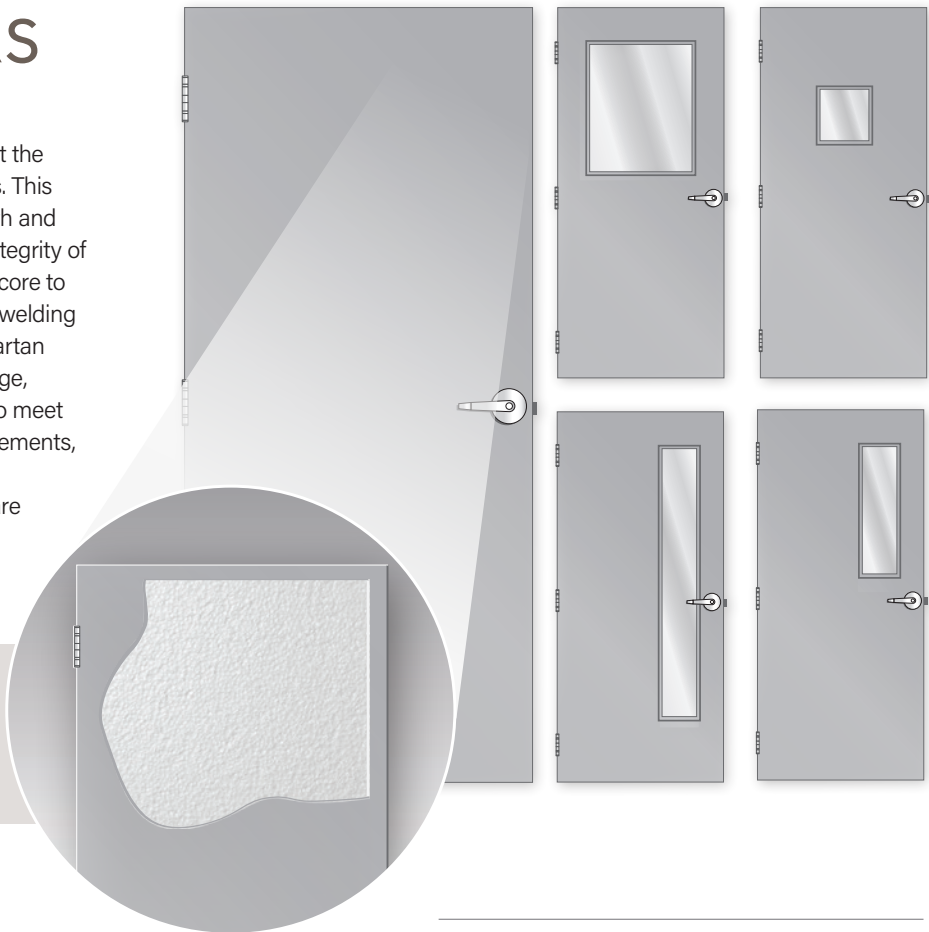

86 LOCK PREP
Optional with face prep

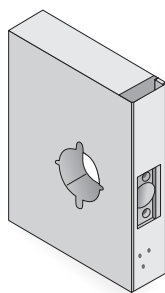

161L LOCK PREP

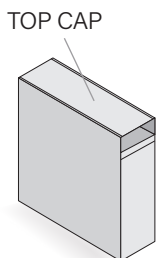

DOOR HEAD

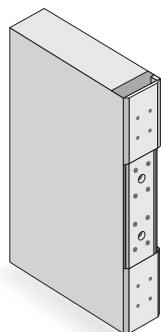

HINGE PREP



Our Spartan Doors and Frames line is proudly Made in Houston with US and global components.



TELL Manufacturing follows the same set of performance specifications as other door manufacturers, as set forth in the Steel Door Institute (SDI) requirements. And UL listed

GENERAL NOTES

1. Edge construction:

- Vertical edges (both hinge and lock) are square with a visible seam.
- Top and bottom edges are closed with inverted 16 - gage welded channels. Exterior applications require the addition of snap-in top caps to protect against the weather.

2. Cores available in the Spartan Door construction:

- Polystyrene, standard, for exterior applications in cold weather conditions.
- Polyurethane option, for exterior applications in extreme weather conditions.

3. Standard hardware preparations—standard mortised and reinforced for:

- Universal Hinge Preps - 4 1/2" (114mm) patented preparation which allows easy and quick field conversion from standard to heavy weight hinges.
- Locks - A multitude of standard lock preps are available. The most commonly used with a 4 7/8" (124mm) strike are 161, 161L and 86.

DOORS AND FRAMES

HOLLOW METAL

Spartan Doors and Frames are manufactured from high quality galvanized steel and are thoroughly cleaned inside and out to insure excellent corrosion resistance and paint adhesion. They come standard with a prime coat, ready to be finished.

Our Spartan Door is available in 18 and 20 gauge steel and the Spartan Frame is 16 gauge standard.



DOOR FEATURES

Door	▪ 18 and 20 gauge Galvanized Steel
Paint	▪ Prime painted standard ▪ Other paint colors available ▪ Custom colors are available, contact customer service
Hinge Prep	▪ Non-handed 4-1/2" - 7 gauge hinge reinforcements, accommodates heavyweight hinges
Fire Rated	▪ Up to 3 hours are certified by Underwriters Laboratories
Channels	▪ 16 gauge inverted top and bottom channel
Insulation	▪ Polystyrene core standard ▪ Polyurethane option available
Top Cap	▪ Installed steel cap standard
Closer Prep	▪ 14 gauge reinforced steel, standard

The Spartan Frames are knock-down construction and are designed to be installed on standard and non-standard wall sizes over pre-finished or unfinished drywall.

FRAME FEATURES

Frame	▪ 16 Gauge Galvanized Steel ▪ Knockdown construction ▪ Precision Mitered Corners ▪ Easy Installation
Paint	▪ Prime painted standard
Closer Prep	▪ 14 gauge reinforced steel, standard
Fire Rated	▪ Up to 3 hours are certified by Underwriters Laboratories



LOCKSET & DEADBOLT READY



CLOSER REINFORCEMENT



TAMPER RESISTANT HINGE

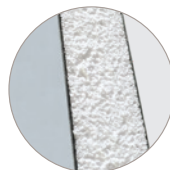

POLYSTYRENE INSULATED CORE

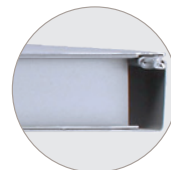

INVERTED TOP AND BOTTOM CHANNEL



STEEL CAP TOP STANDARD

DRYWALL FRAMES

STANDARD FEATURES

All Spartan Drywall Frames come with adjustable compression anchors in each jamb. These anchors provide a tight rigid fit in the opening.

- 16 gauge for 1 3/4" doors
- Precision fitted corners
- Galvannealed (standard)
- 7 gauge hinge reinforcements
- Heavy duty strike reinforcements
- Universal 4 1/2" hinge prep
- Fire rated up to 1 1/2 hours
- Meets ANSI standards

TYPICAL BASE AND WALL ANCHORS

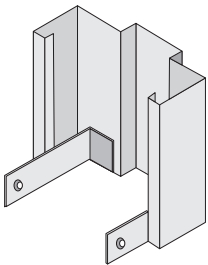

STRAP ANCHOR

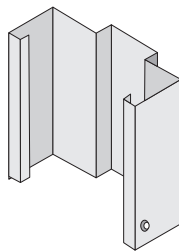

DIMPLE ANCHOR

MASONRY FRAMES

STANDARD FEATURES

All Spartan Masonry Frames come with 1/2" returns. Masonry, Wood, and Existing Opening Anchoring (E.O.A.) systems are all available.

- 16 gauge for 1 3/4" doors
- Precision fitted corners
- Galvannealed (standard)
- 7 gauge hinge reinforcements
- Heavy duty strike reinforcements
- Universal 4 1/2" hinge prep
- Fire rated up to 3 hours
- Meets ANSI standards

TYPICAL BASE AND WALL ANCHORS

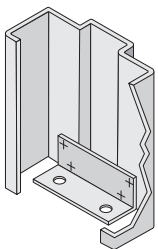

ONE PIECE WELDED
BASED ANCHOR

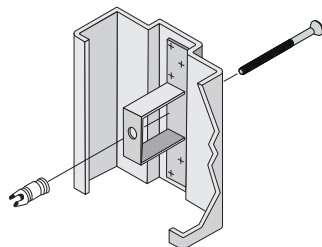

EXISTING OPENING
ANCHOR (E.O.A.)

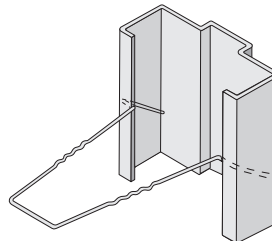

MASONRY WIRE
ANCHOR

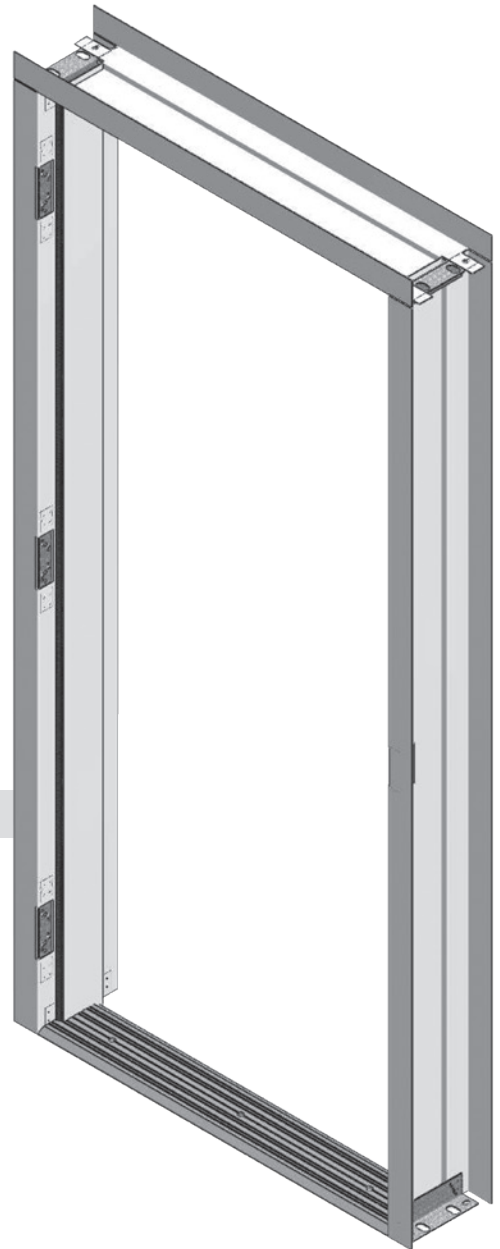

DOOR DIMENSIONS

Top



Hinge Side

Hinge Close Up

Latch Close Up

Latch Side

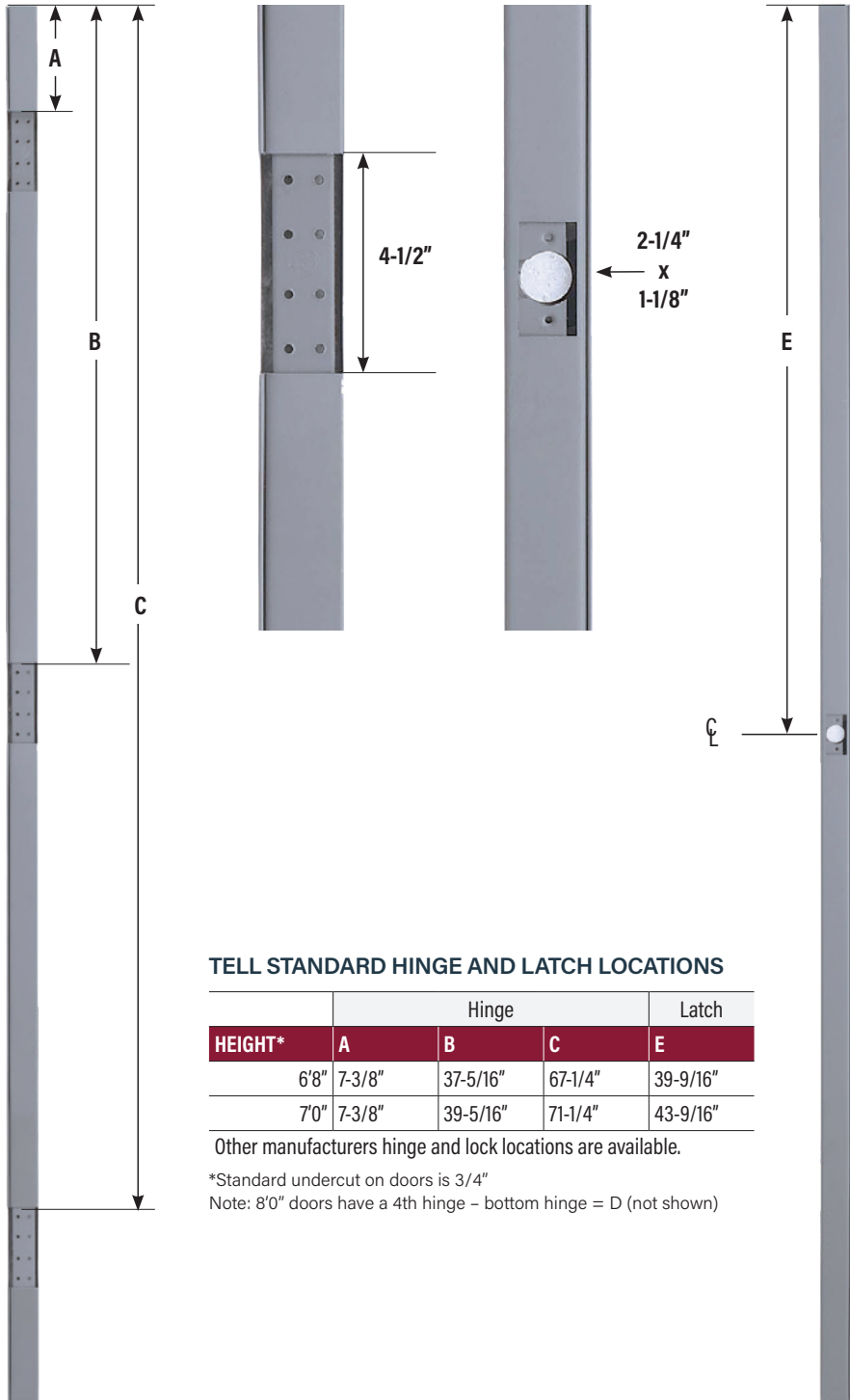

TELL STANDARD HINGE AND LATCH LOCATIONS

HEIGHT*	Hinge			Latch
	A	B	C	E
6'8"	7-3/8"	37-5/16"	67-1/4"	39-9/16"
7'0"	7-3/8"	39-5/16"	71-1/4"	43-9/16"

Other manufacturers hinge and lock locations are available.

*Standard undercut on doors is 3/4"

Note: 8'0" doors have a 4th hinge - bottom hinge = D (not shown)

Bottom

DETAILS

- Insulated with polystyrene core
- Non-handed
- Galvannealed (standard)
- Fire rated up to 3 hours
- 7 gauge hinge reinforcements
- Reinforced 161 lock prep
- Closer reinforcement (standard)
- Meets ANSI standards
- Universal 4 1/2" hinge prep
- Inverted top and bottom channel
- Installed steel cap standard
- Available with polyurethane core

PAINT OPTIONS



*Med Gray,
PR



Light Gray,
GR



Bronze,
BZ



Off White,
OW



True White,
WH



Bright White,
BW

NOTE: Actual colors may vary from those shown due to limitations of the printing production process.



CORPORATE OFFICE:

18 Richard Drive
Lititz, PA 17543
toll free: 800-433-4047
fax: 888-370-3253

tell.sales@spectrumbrands.com

OTHER LOCATIONS:

Birmingham, AL
Mira Loma, CA
Elkhart, IN,
Dallas, TX
Houston, TX

tellmfg.com